

**AGES 9+**  
**FOR 2 TO 6 PLAYERS**



## OBJECT

Travel the path of LIFE making decisions, building a family, earning money (and paying some out too), buying homes and collecting LIFE tiles. Have the highest value at the end of the game and win.

## CONTENTS

### Adult Assembly Required

• Gameboard • 6 Plastic Car Pawns • Pink and Blue "People" Pegs • 3 Mountains • 1 Bridge • 7 Buildings • Label Sheet • Spinner Base, Ring and Dial • Stack of Play Money, Bank Loans and Pay Raises • 25 LIFE Tiles • 24 *Spin to Win* Tokens • Deck of 54 Cards • Banker's Tray • *Spin to Win* Strip

## SETTING UP

### ASSEMBLY

Carefully detach all of the cardboard pieces from the parts sheet. Discard the cardboard waste.

Carefully remove the buildings, mountains, bridge, spinner base and spinner dial from the plastic frames. If needed, use an emery board or sandpaper to remove the excess plastic from the game pieces. Discard the frame after removing all of the game pieces.

### APPLY LABELS TO THE MOUNTAINS AND BRIDGE

Match the letters next to each of the four labels to the circled letters on the plastic mountains and bridge. Apply the labels to the matching plastic pieces as shown at the right.

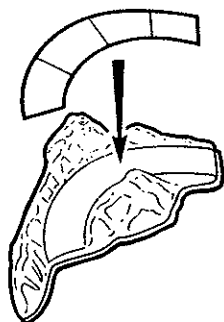

### ASSEMBLE THE SPINNER

Take the spinner ring and match the double-notched section of the spinner ring to the double-tabbed section on the underside of the plastic spinner dial (under the number 8), then snap the ring into the dial by sliding the ring under each of the plastic tabs. Next, place the assembled dial onto the orange peg in the center of the spinner base. Then insert the feather pin into the hole in the base, as shown.

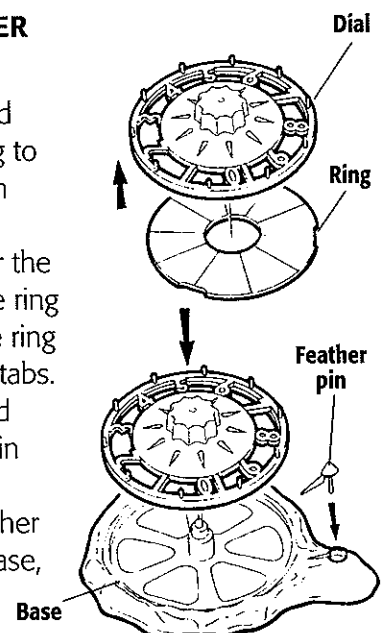

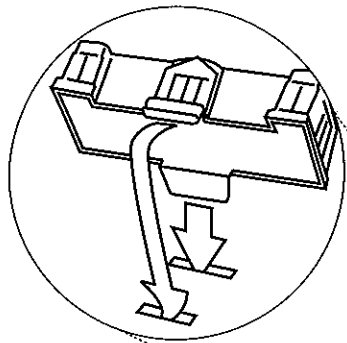

**ATTACH THE BUILDINGS, MOUNTAINS, BRIDGE AND SPINNER**

**1. Buildings, Mountains & Bridge:**

Match the circled letters on the plastic buildings, mountains and bridge to the letters on the gameboard. Then insert each piece by first sliding the long tab through the slot and under the gameboard, then press down to secure the small tab into place.

**2. Spinner:** Match the circled letter on the plastic spinner to the letter on the gameboard. Then insert the 3 posts on the spinner base into the 3 holes in the gameboard. *NOTE: The spinner can be removed at any time and passed around for easier play.*

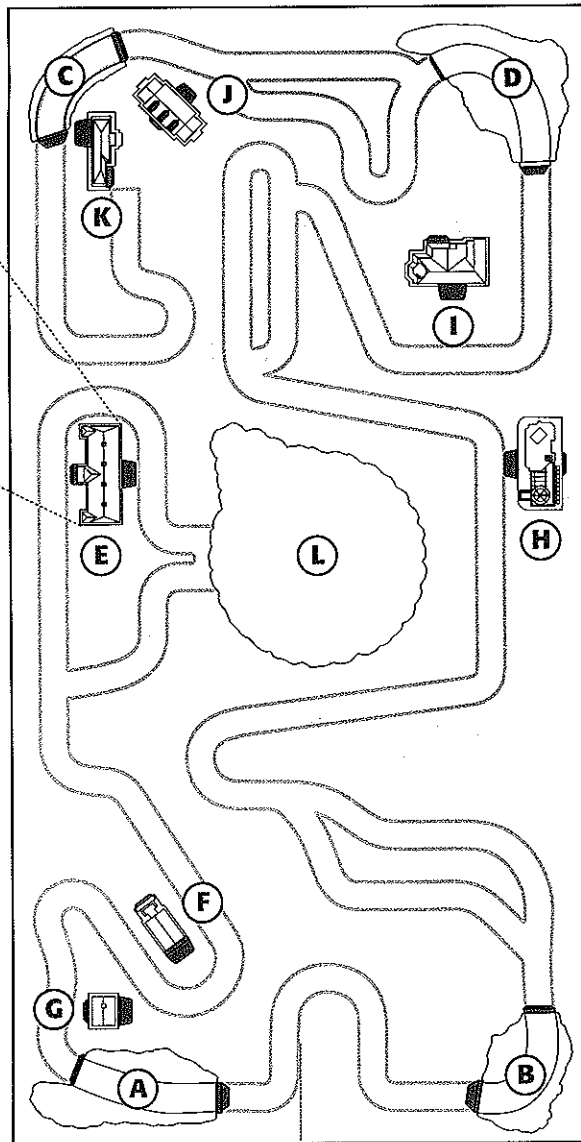

**SPIN TO WIN STRIP**

Place the multi-color Spin to Win Strip along any edge of the gameboard.



**CARDS**

Separate the cards into six decks (according to the card backs): College Career cards, Career cards, Starter Home Deeds, House Deeds, Share the Wealth cards, and Long-Term Investments. Shuffle each deck separately and then place them facedown in piles near the gameboard.

Now deal three Share the Wealth cards to each player.

**LIFE TILES**

Each LIFE tile carries a dollar amount that counts toward your total cash value at the end of the game.

Place the LIFE tiles value-side down on the table and mix them up. Then randomly draw three tiles and stack them LIFE-side-up at Millionaire Estates. Place the remaining tiles near the edge of the gameboard to form a draw pile.

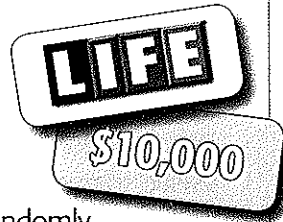

**SPIN TO WIN TOKENS**

Place all of the Spin to Win tokens in a pile near the edge of the gameboard.



**LONG-TERM INVESTMENTS**

At the beginning of any of your turns you may buy one Long-Term Investment card. Pay the banker \$10,000 and take any Long-Term Investment card from the deck. It's your choice which one you pick. From now on, whenever any player (including you) spins the number on your Long-Term Investment card, you collect \$5,000 from the bank!

You can only have one Long-Term Investment at a time.

**MONEY, BANK LOANS AND PAY RAISES**

Choose one player to be the banker. This player is in charge of all money paid to and from the bank as well as issuing bank loans and handing out pay raises.



The banker separates the Bank Loans, Pay Raises and money by denomination and places each into the slots in the Banker's Tray.

The banker then gives each player \$10,000.

### CARS AND PEGS

Carefully twist the pink and blue pegs off their plastic runners. Discard the runners. Put the pegs in a pile near the edge of the gameboard. Choose a car and fit a people peg into the driver's seat (don't forget to buckle up!). All players do the same. Place any extra cars back in the box.

## GAMEPLAY

All players spin the spinner. The player with the highest spin takes the first turn. Play then continues clockwise.

### WHAT YOU DO ON A TURN

On your turn, spin the spinner. (If the spinner arm stops between numbers, spin again.) Then move your car the number of spaces spun.

Always move your car forward, in the direction of the arrows. (Just like in real life, you can't go back in time!) If you land on an occupied space, move ahead to the next open space. Now, follow the space directions. This ends your turn. Your first turn is an exception. See *GETTING STARTED*.

### GETTING STARTED

On your first turn, decide to either **Start a Career** or to **Start College**. College offers more career and salary options, but it takes time – and it puts you in debt!

### START A CAREER

If you decide to start a career, place your car on the START CAREER space, then do the following:

**Draw a Career Card:** Have another player fan out the Career card deck facedown, while you randomly draw **one** card. The card will list your career, salary, salary maximum and taxes due. *NOTE: You may not choose a College Career card. These are reserved for college graduates only.*

Place your Career card faceup in front of you. Now spin the spinner and move as you would on a regular turn.



### START COLLEGE

If you decide to go to college, place your car on the START COLLEGE space. Borrow \$100,000 from the bank for tuition (see BANK LOANS on page 2). Now spin and move as you would on a regular turn.



### THE SPACES

#### SPACE COLORS

As you move your car, notice the space colors – they're important!

#### YELLOW SPACES

Most spaces are yellow. Whenever you land on a yellow space, you must follow the directions.

#### COLLECT/PAY SPACES

Collect from or pay to the bank the amount of money indicated on the space.

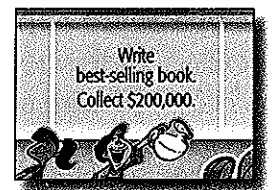

#### LIFE SPACES

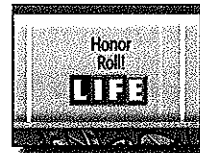

These spaces show pictures of LIFE tiles, and are all about family activities, community service and good deeds! Whenever you land on a LIFE space, take one LIFE tile from the draw pile. If the draw pile runs out, take one LIFE tile from any opponent. Do not look at the value side of the LIFE tile, just place it LIFE-side-up in front of you.

#### TAXES DUE

Pay the bank the amount of taxes shown on your Career/College Career card.

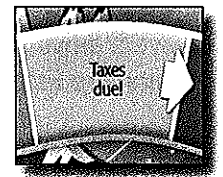

#### TAX REFUND

Collect from the bank the amount of taxes shown on your Career/College Career card.

#### LOSE YOUR JOB



Land here and you **MUST** trade in your Career/College Career card for a new one. Have another player fan out the Career card deck facedown.

Randomly draw one card. **IMPORTANT:** When you lose your job, you also lose all of your pay raises and you must choose your new career from the Career card deck, **NOT** the College Career card deck regardless if you went to college or not.

### BABIES AND TWINS

Whenever you land on a Baby Boy or Baby Girl space, add one "people" peg to your car, collect a \$5,000 baby gift from each of the other players and take one LIFE token from the draw pile. If you land on a Twins space, add two "people" pegs to your car, collect a \$5,000 gift from each of the other players and take one LIFE tile from the draw pile.

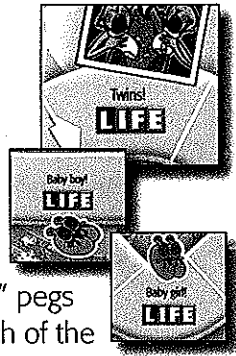

### SPIN TO WIN



Land on one of these spaces and all players get a chance to *Spin to Win*. Play any *Spin to Win* cards to increase your chances. Take one *Spin to Win* token from the draw pile (matching

the color of your car) and place it on any number on the *Spin to Win* Strip. Then pay your investment (up to \$50,000) to the bank. Now spin the spinner.

- If the number spun matches the number you chose, the bank pays you 10 times the amount you invested.
- If the number spun does not match the number you chose, you lose your investment. Place the token back in the draw pile.

### GREEN SPACES

#### PAY DAY

Whenever you land on or pass over a green PAY DAY space, collect your salary from the bank.

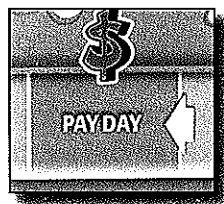

#### PAY DAY – PAY RAISE

Some PAY DAY spaces have Pay Raises attached to them. When you land on or pass over a PAY DAY space with a Pay Raise on it, take a Pay Raise from the bank and place it near your Career card. Then add that \$10,000 to your current salary. If your salary is already at its maximum, just collect your current maximum salary and ignore this raise.

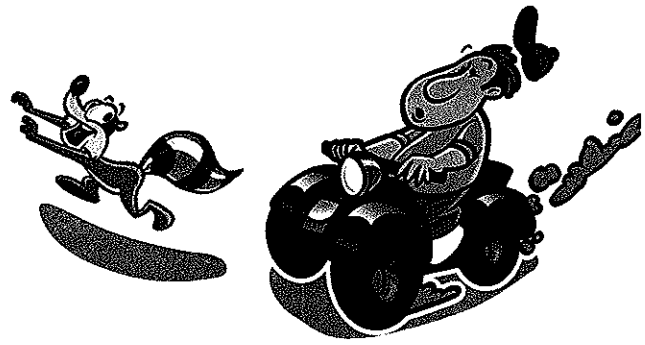

### ORANGE SPACES

Whenever you reach an orange space, **STOP!** – even if you have moves left. Follow the directions, then, *spin and move again*.

Most orange spaces represent important LIFE choices that you will have to make.

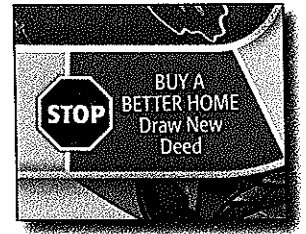

### COLLEGE CAREER CHOICE

Choose your College Career card: Have another player fan out the College Career cards facedown, then randomly draw **two** cards. Look at the cards and choose one. The card will list your career, salary, salary maximum and taxes due. Place the card you chose faceup in front of you and return the other card to the deck.

### GET MARRIED

Add one "people" peg to your car and take a LIFE tile. Then spin for your wedding gifts. If you spin a 10, 9 or 8, the other players must each give you \$10,000. If you spin a 7, 6 or 5, the other players must each give you \$5,000. If you spin a 4, 3, 2 or 1, you receive nothing. **NOTE:** If you can't afford to give a wedding gift, you **MUST** borrow from the bank.

### BUY A STARTER HOME

Take a look at all the available Starter Home cards. Decide which one you want to buy and pay the bank the price on the card. If you're short on cash, you **MUST** borrow from the bank.

### RETURN TO SCHOOL

Before you spin, choose to return to school or continue on the path of life. If you choose to return to school, pay \$50,000 to the bank.

### CHANGE CAREER

You may choose to change your Career card for a College Career card or you may take a \$20,000 salary increase.

- If you choose to take a new College Career card, have another player fan out the College Career cards facedown and randomly draw two cards. Choose either card for your new career; or choose neither and keep your current Career card. Return the cards you didn't choose to the deck.
- If you choose the salary increase, take two Pay Raises from the bank and place them near your Career card.

### FAMILY PATH

Before you spin, choose either to take the family path and increase your chances of having children, or to continue on the path of life.

### BUY A "BETTER" HOUSE

Decide if you want to sell your Starter House and buy a better one. If so, look at the House cards and choose the house you want to buy. If you decide to buy a better one, sell your Starter House back to the bank for the selling price listed on its card, then pay the bank the price on the new card. If you're short on cash, borrow from the bank. *NOTE: You can never own two houses at the same time. If you already own a house, you must sell it before you can buy a new one.*

### RISKY PATH

Before you spin, decide if you want to take the Risky path, which contains many *Spin to Win* opportunities, or the Safe path, and spend time with your family.

### BLUE LAWSUIT SPACES

Whenever you land on a blue Lawsuit space, collect \$100,000 from the player of your choice.



### BANK LOANS

You may borrow money from the bank during any of your turns. Take one or more bank loans (each loan is worth \$20,000). The banker gives you the matching amount from the bank.

Repay all loans to the bank with \$5,000 interest (that means you must repay \$25,000 for each bank loan). You may pay these off at any time during the game or wait until you retire at the end of the game.

### SHARE THE WEALTH CARDS

There are five kinds of Share the Wealth cards. If you have any, keep them facedown so only you will know what they are. Use these cards when you choose, but use them wisely. Here's what they can do...



**COLLECT CARD:** Give these cards to your opponents when they land on yellow COLLECT spaces. Now they have to give YOU half of the money they collected. After you play the card, discard it to the bottom of the deck.

**PAY CARD:** Give these cards to your opponents when YOU land on a yellow PAY space. Your opponent must now pay the bank half of what you owe for the space. After you play the card, discard it to the bottom of the deck.

**EXEMPTION CARD:** These cards allow you to ignore COLLECT or PAY cards when an opponent gives you one as well as LAWSUITS. Just show this card to your opponent, then discard it along with your opponent's card to the bottom of the deck. *NOTE: Only one card may be given to an opponent in a turn. If two or more players wish to give an opponent a card, each of you must spin the spinner. If you spin the highest number, only you give your opponent a card.*

**SPIN TO WIN (2):** These cards allow you to use two *Spin to Win* tokens instead of one when someone lands on a *Spin to Win* space. Take two tokens (matching the color of your car) from the draw pile and place them on any two numbers on the *Spin to Win* Strip. Give your investment to the bank. Now, spin the spinner. If the number spun matches one of your numbers, the bank pays you 10 times the amount you invested. If the number does not match, you lose your investment. Return the two tokens to the pile and discard the card to the bottom of the deck.

**SPIN TO WIN (4):** These cards allows you to use four *Spin to Win* tokens instead of one when someone lands on a *Spin to Win* space. Take four tokens (matching the color of your car) from the draw pile and place them on any four numbers on the *Spin to Win* Strip. Give your investment to the bank. Now, spin the spinner. If the number spun matches one of your numbers, the bank pays you 10 times the amount of money you invested. If the number does not match, you lose your investment. Return the four tokens to the pile and discard the card to the bottom of the deck.

## HIGHWAY PATROL

Any opponent caught speeding (spinning "10") must pay the Police Officer \$5,000! It's up to the Police Officer to notice when a player spins a "10". If you don't notice, the "speeder" gets away and pays no fine.

*NOTE: If there's no Police Officer in the game, there's no fine for spinning "10."*

## RETIREMENT

When you reach the end of the path of life, STOP! – even if you have moves left. Then do the following:

- Repay to the bank any, and all, outstanding loans with interest.
- Sell your house back to the bank for the amount listed on the card.
- Place your Career card and Pay Raise(s) out of play.
- Keep your Long-Term Investment card – you will still spin on your turn and can still collect whenever your number is spun!
- Keep your Share the Wealth cards. These can still be played.
- Collect a \$10,000 retirement gift from each of your children by collecting the amount from the bank.
- Choose to retire at Millionaire Estates or Countryside Acres (wherever you decide to retire, wait there until all other players have retired).

## RETIRING AT MILLIONAIRE ESTATES

- If you are the first player to retire at Millionaire Estates, take a look at the three LIFE tiles there, choose one and return the other two to the space. The second player to retire may choose from the remaining two LIFE tiles and the third player to retire will take the last LIFE tile. Any players arriving after that get no tiles for retiring at Millionaire Estates.
- If you retire at Millionaire Estates, your LIFE tiles are NOT safe! If the draw pile runs out, players may take tiles from you when they land on LIFE spaces.

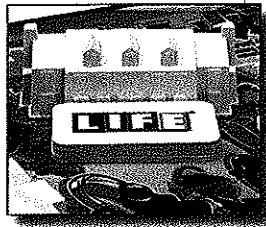

## RETIRING AT COUNTRYSIDE ACRES

- You get no additional LIFE tiles for retiring at Countryside Acres, however, your LIFE tiles are safe! If the draw pile runs out, players cannot take tiles from you when they land on LIFE spaces.



## HOW TO WIN

Once all players have retired, you add up your total value.

1. Count your cash.
2. Turn over your LIFE tiles money-side-up and add up the dollar amounts.
3. Add the two figures together (cash value plus LIFE tile value).

The player with the highest total value wins!

## STORAGE

When you have finished playing, you do not need to detach the buildings, mountains or bridge before storing your game back in the box. To easily store your game...

1. Place the center of the gameboard, with the spinner, into the box.
2. Then fold the end of the gameboard with the bridge over the center section.
3. Now place all components and tray into the box.
4. Fold the remaining end of the gameboard over into the box.
5. Place the cover on the box and store until your next gameplay.

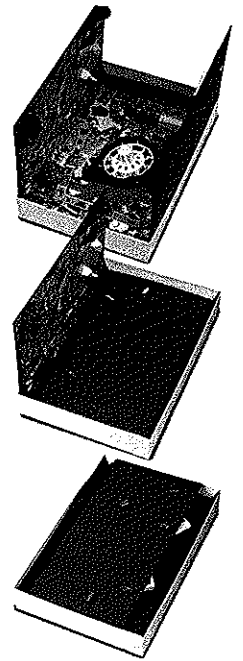

We will be happy to hear your questions or comments about this game. Please write to: Hasbro Games, Consumer Affairs Dept., P.O. Box 200, Pawtucket, RI 02862 USA. Tel: 888-836-7025 (toll free). European consumers please write to: Hasbro UK Ltd., Hasbro Consumer Affairs, P.O. BOX 43, Caswell Way, Newport, Wales, NP19 4YD, or telephone our helpline on 00 800 2242 7276.

©2007 Hasbro, Pawtucket, RI 02862. All Rights Reserved. TM and ® denote U.S. Trademarks. 1014000X00

